

XDC-4200S

Digital Cinema Xenon Lamp

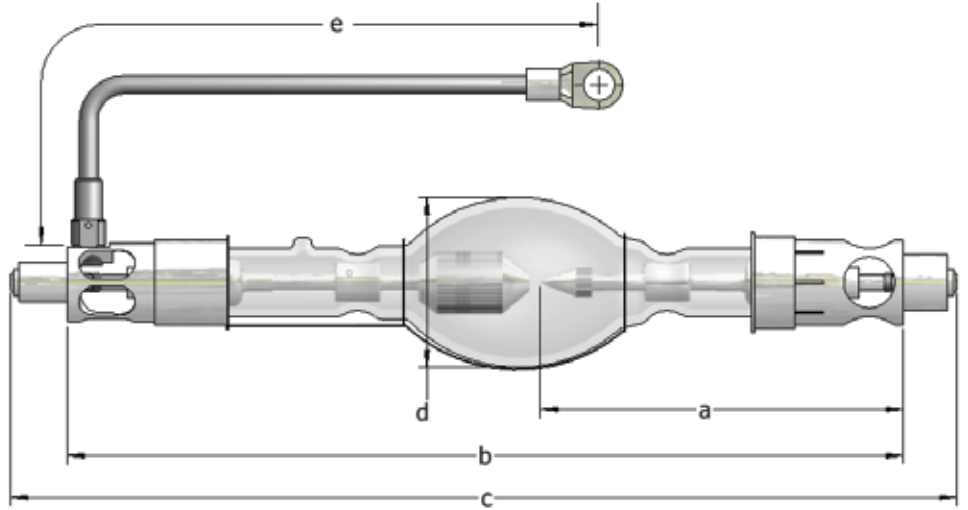

APPLICATIONS

Sony SRX-R220, SRX-R320

TECHNICAL SPECIFICATIONS

Rated Power	W	4200
Rated Current	A	120
Operating Current Range	A	80-130
Rated Voltage	V	33
Distance a	mm	128
Length b	mm	295
Length c (max)	mm	334
Cold arc gap	mm	4.7
Bulb Diameter d	mm	60
Anode (+) Base Diameter	mm	28
Anode Pin Diameter	mm	14
Cathode (-) Base Diameter	mm	30
Cathode Pin Diameter	mm	20
Cable Length e	mm	203
Horizontal Operating Position	deg	±15
Min. Cooling Air Flow Velocity	m/sec	7
Base Surface Temperature (max)	deg C	200

WARRANTY: 700 hours (100%)



Lighting Technologies International LLC
13700 Live Oak Avenue, Baldwin Park, CA,
USA 91706
www.ltilighting.com

Rev. 4 / 2020
Subject to Change