

XDC-4500NL

Digital Cinema Xenon Lamp

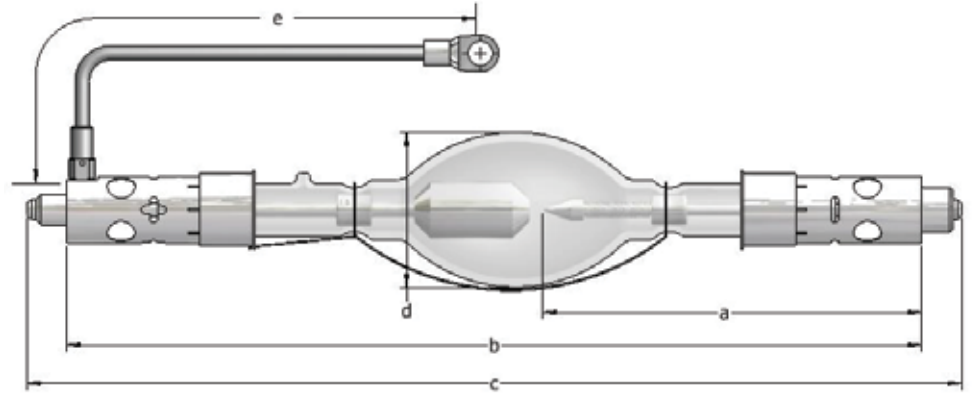

APPLICATIONS

NEC NC2500S, NC3200S, NC3240S

TECHNICAL SPECIFICATIONS

Rated Power	W	4500
Rated Current	A	140
Operating Current Range	A	95-150
Rated Voltage	V	32
Distance a	mm	171.5
Length b	mm	387
Length c (max)	mm	423
Cold arc gap	mm	6.0
Bulb Diameter d	mm	70
Anode (+) Base Diameter	mm	30
Anode Pin Diameter	mm	14
Cathode (-) Base Diameter	mm	30
Cathode Pin Diameter	mm	20
Cable Length e	mm	220
Horizontal Operating Position	deg	± 15
Min. Cooling Air Flow Velocity	m/sec	7
Base Surface Temperature (max)	deg C	200

WARRANTY: 1300 hours (100%)

