

XDC-4500N

Digital Cinema Xenon Lamp

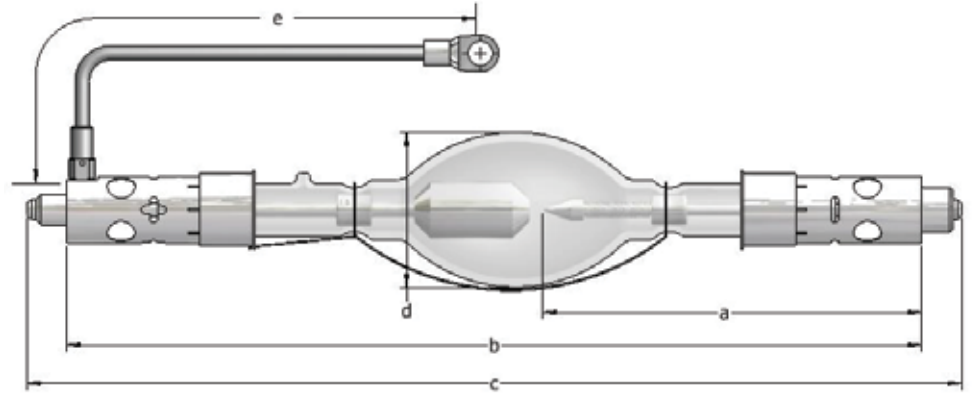

APPLICATIONS

Barco NC2500S, NC3200S, NC3240S

TECHNICAL SPECIFICATIONS

Rated Power	W	4500
Rated Current	A	140
Operating Current Range	A	100-150
Rated Voltage	V	32 (+/-2)
Distance a	mm	171.5
Length b	mm	387
Length c (max)	mm	425
Cold arc gap	mm	6.0
Bulb Diameter d	mm	70
Anode (+) Base Diameter	mm	30
Anode Pin Diameter	mm	13.9
Cathode (-) Base Diameter	mm	30
Cathode Pin Diameter	mm	20
Cable Length e	mm	750
Horizontal Operating Position	deg	±20
Min. Cooling Air Flow Velocity	m/sec	6
Base Surface Temperature (max)	deg C	200

WARRANTY: 900 hours (100%)

