

XDC-2000B

Digital Cinema Xenon Lamp

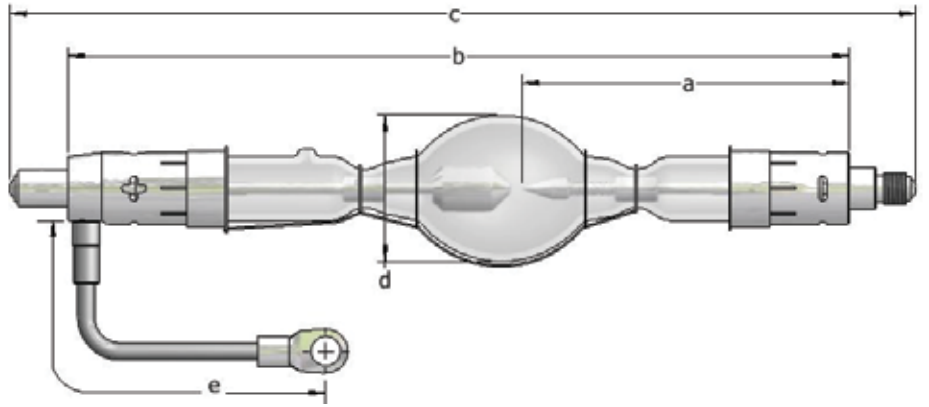

APPLICATIONS

Barco	DP2K-8S, 10S, 12C, 15C, 19B, 20C, 23B DP4K-23B, DP-1200, DP-1500, DP-2000
-------	--

TECHNICAL SPECIFICATIONS

Rated Power	W	2000
Rated Current	A	80
Operating Current Range	A	60-85
Rated Voltage	V	25 (+/-2)
Distance a	mm	123
Length b	mm	294
Length c (max)	mm	341
Cold arc gap	mm	4.6
Bulb Diameter d	mm	55
Anode (+) Base Diameter	mm	27
Anode Pin Diameter	mm	13.9
Cathode (-) Base Diameter	mm	27
Cathode Pin Diameter	mm	M12 x 1.75
Cable Length e	mm	140
Horizontal Operating Position	deg	±15
Min. Cooling Air Flow Velocity	m/sec	7
Base Surface Temperature (max)	deg C	200

WARRANTY: 2400 hours (100%)

