

# XDC-1600C

Digital Cinema Xenon Lamp

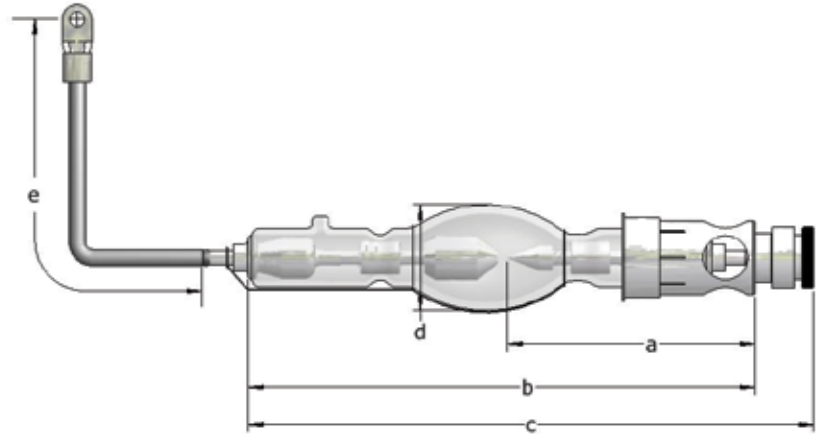

## APPLICATIONS

Christie Solaria One/One+, CP2208, CP2210, CP2215

## TECHNICAL SPECIFICATIONS

Rated Power	W	1600
Rated Current	A	60
Operating Current Range	A	40-70
Rated Voltage	V	27
Distance a	mm	100.5
Length b	mm	221
Length c (max)	mm	243
Cold arc gap	mm	3.81
Bulb Diameter d	mm	43
Anode (+) Base Diameter	mm	N/A
Anode Pin Diameter	mm	N/A
Cathode (-) Base Diameter	mm	30
Cathode Pin Diameter	mm	20
Cable Length e	mm	147.5
Horizontal Operating Position	deg	±5
Min. Cooling Air Flow Velocity	m/sec	4
Base Surface Temperature (max)	deg C	200

WARRANTY: 3000 hours (100%)

